



CranPlas

Sanitary Products

CODE: **CP107**

40mm P Trap 76mm Seal



Dimensions

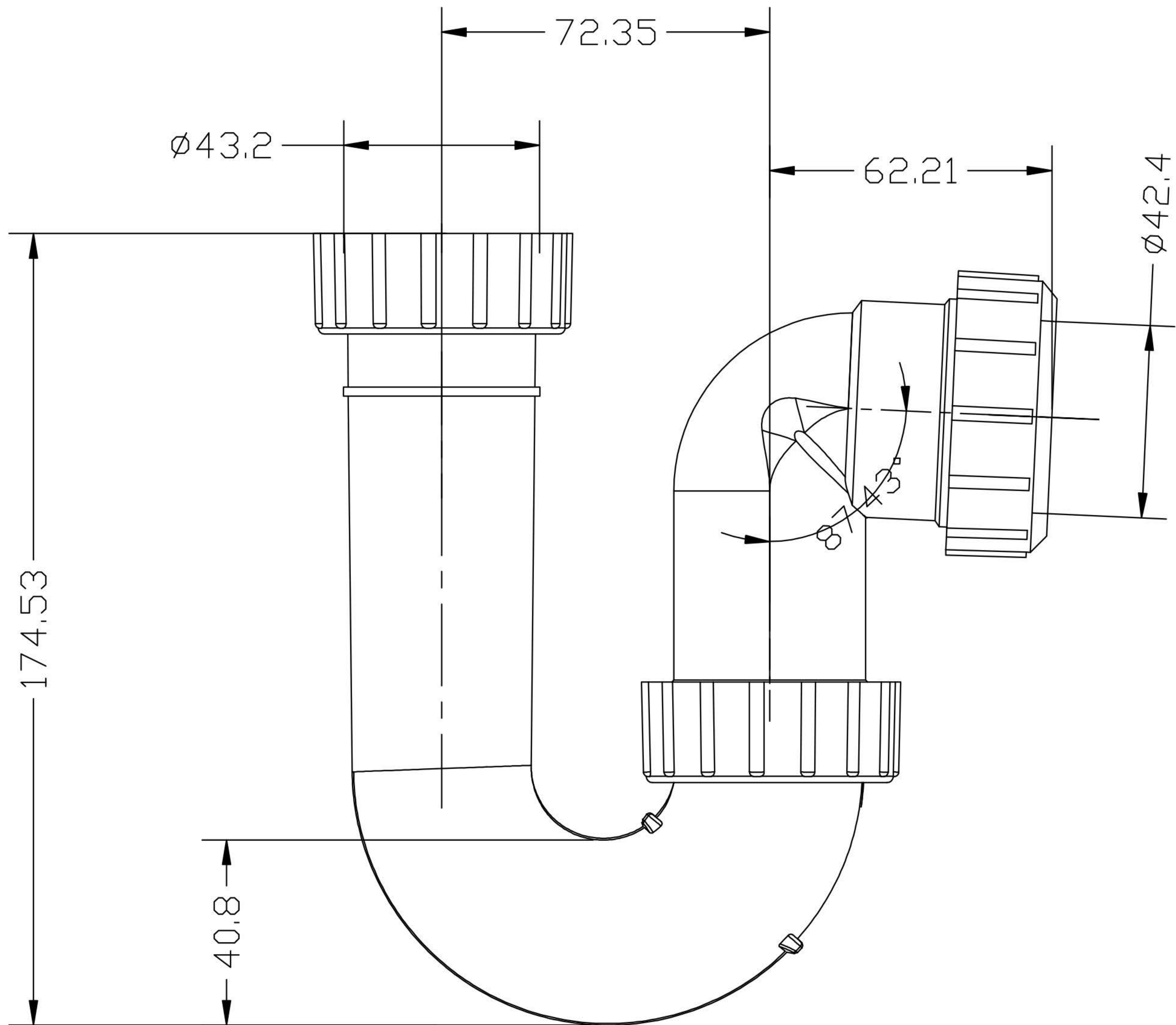

All drawings contain the necessary measurements which are subject to standard tolerances. Exact measurements, in particular for customised installation scenarios, can only be taken from the finished ceramic piece.